



PRO X

Basin mixer, projection 100 mm, fixed spout, Eco+ function, without pop-up waste, chrome

Application : Basin

Faucet type : Single-lever

Installation type : Deck-mounted

Commodity Code/Import Code Number for Foreign Trad : 84818019

Flow rate (l/min - 3 bar) : 4.1

Net weight (kg) : 0.01

TECHNICAL DRAWINGS

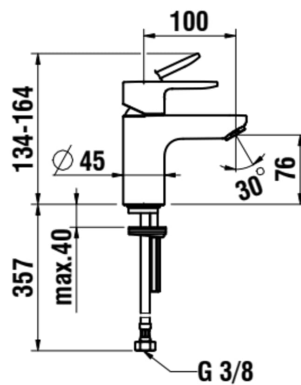



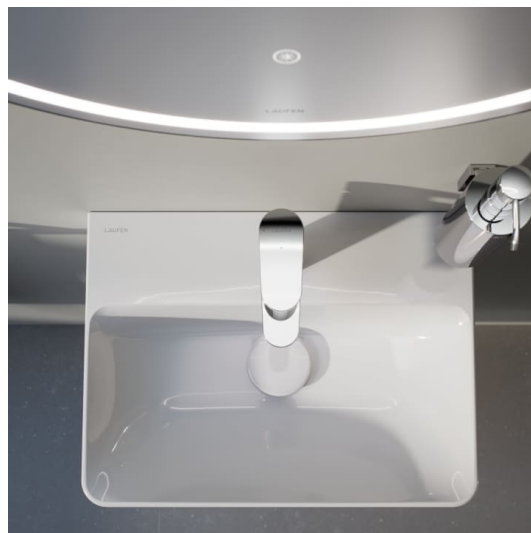
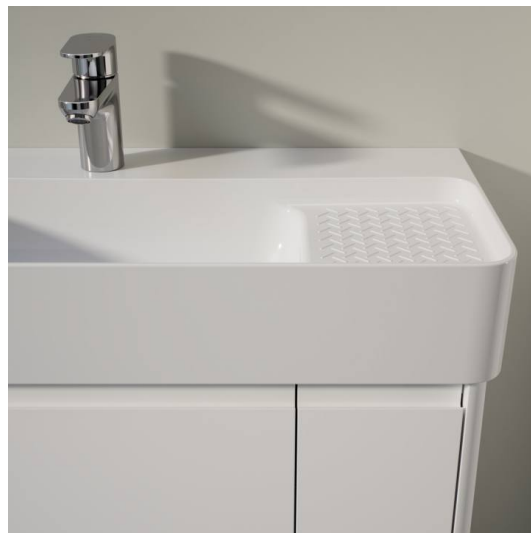



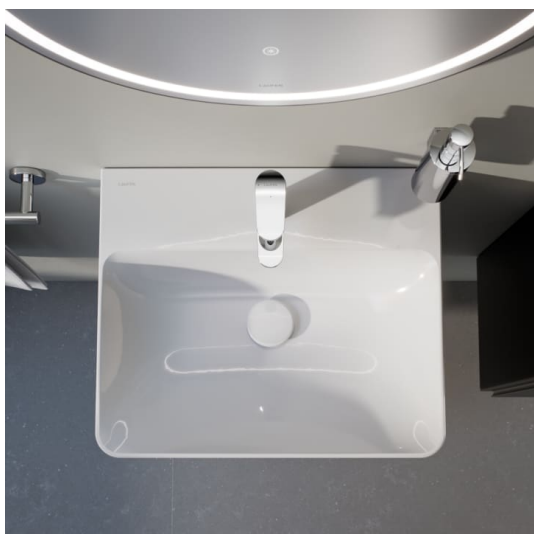
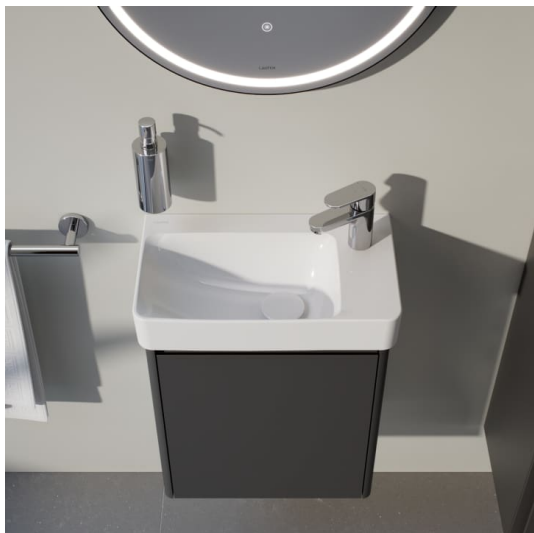





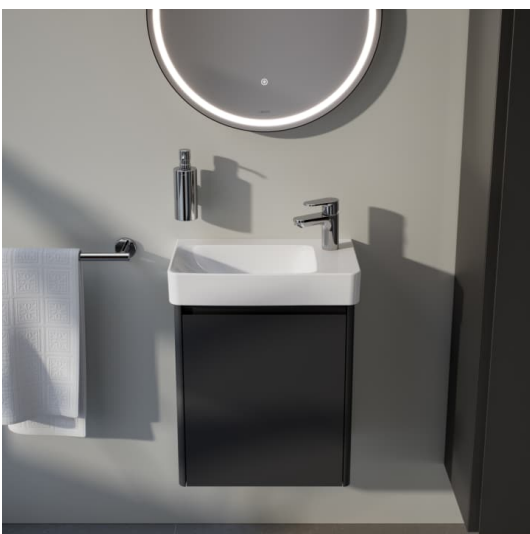



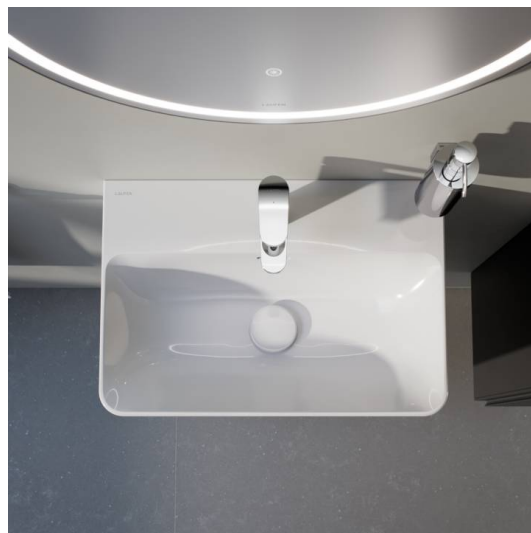



PRO X

Marking the third generation of this highly successful collection, PRO X integrates timeless aesthetics with cutting-edge technology to deliver maximum investment security. Designed to meet the needs of private homes, hospitality projects, and public spaces, it offers a versatile and contemporary solution for modern bathrooms.



#certification_text

Standards and approvals: A+